

BRAUN

MultiQuick 5 Pro



Type HB501BI

Register your product
www.braunhousehold.com/register

Hand blender

English 12

عربي 13

© Copyright 2023 All rights reserved
De'Longhi Braun Household GmbH
Carl-Ulrich-Straße 4
63263 Neu-Isenburg/Germany

5722170081/12.23

UK/AR



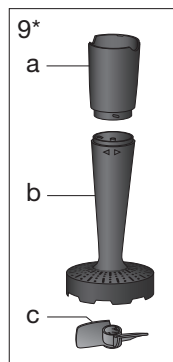
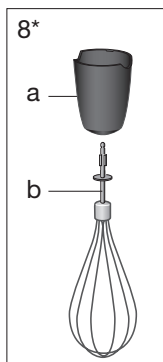





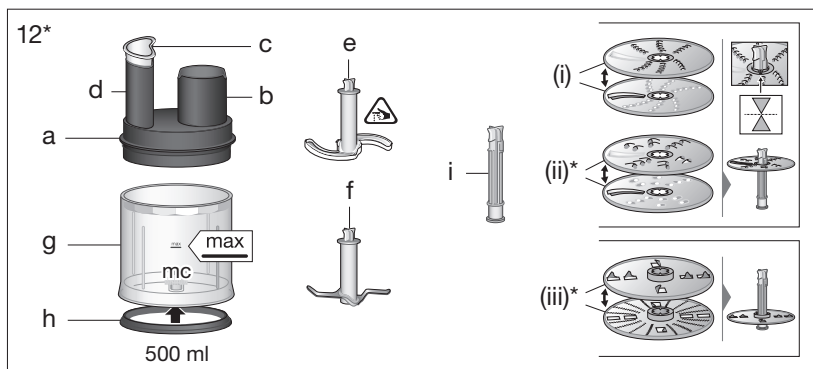
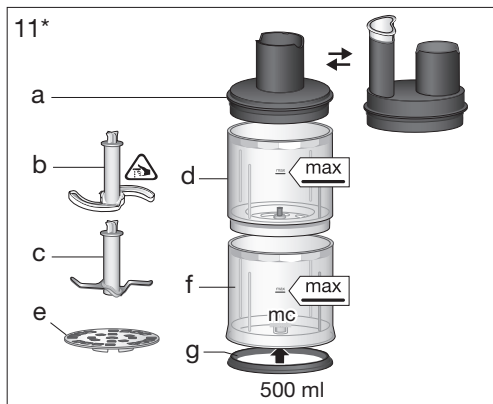
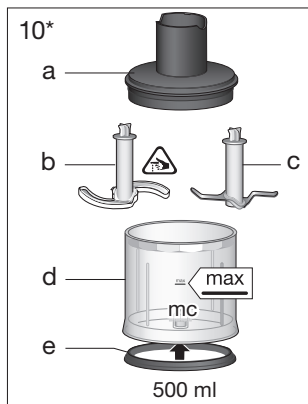

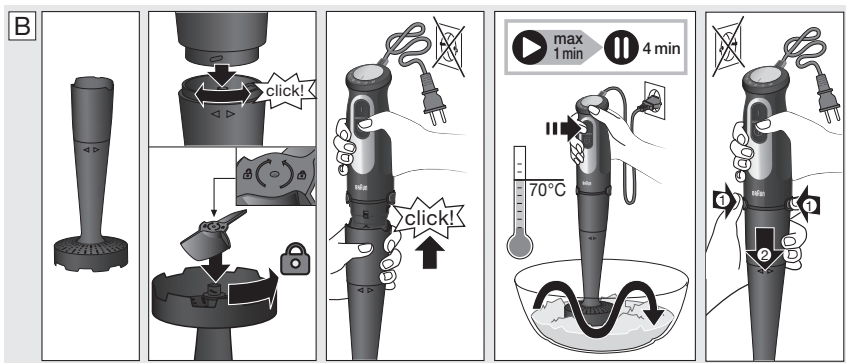
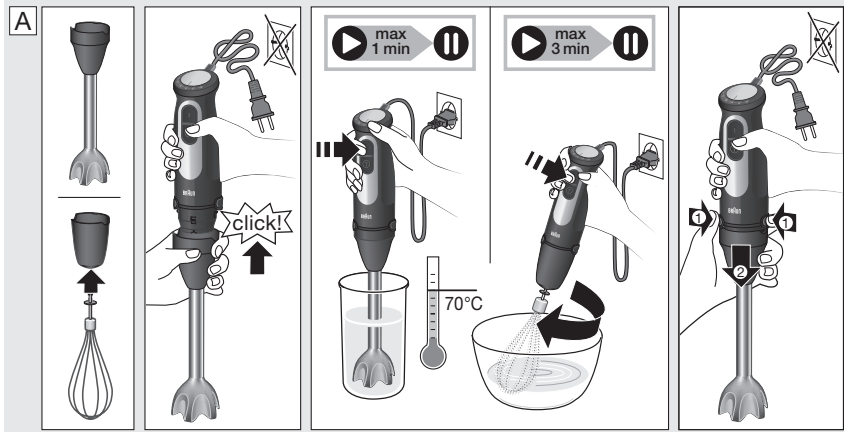

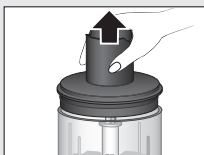
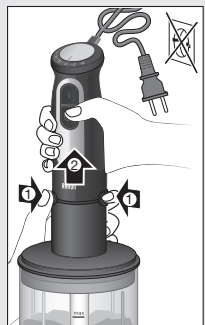
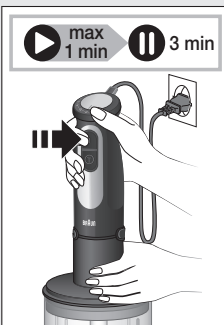
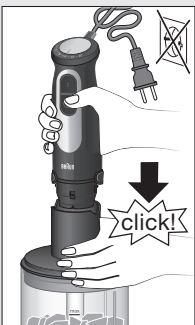
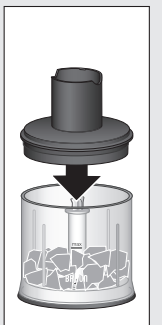
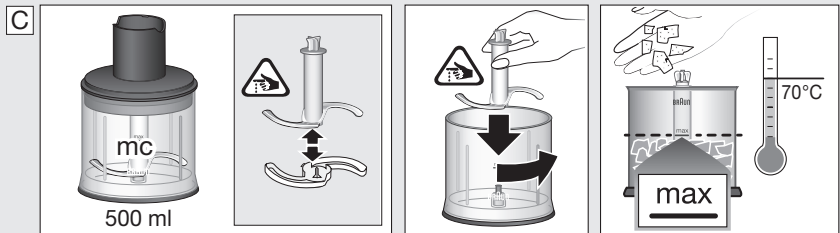













220-240V~ 50-60Hz 750-1000 W

* certain models only





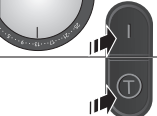

									
									
									
max.	300 g	200 g	200 g	30 g	20	200 g	300 g	350 g	5 
 sec.	10-25	20-30	5-10	5-10	5-10	10	20	30	5-10x pulse
			1 - 9		1 - 25	1 - 25	21	13 - 25	13 - 25
	turbo	turbo		turbo					turbo

D

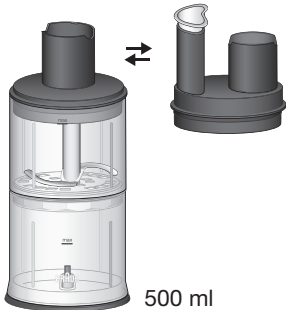



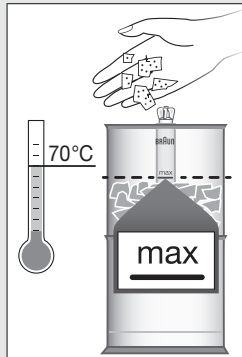
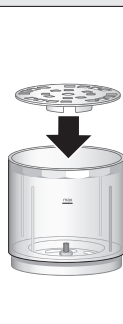



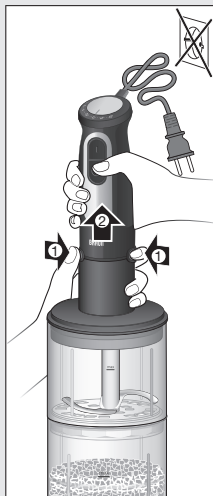

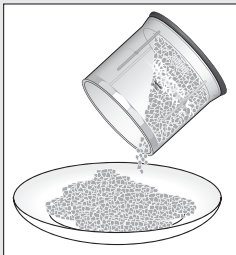
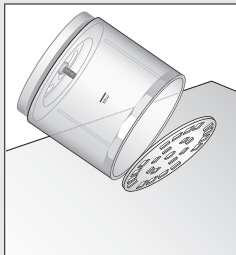
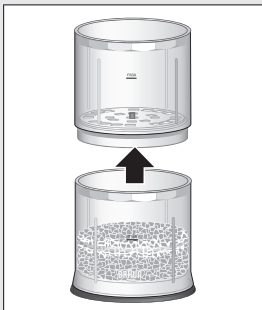
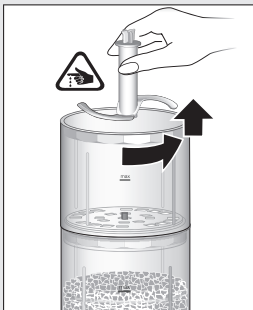
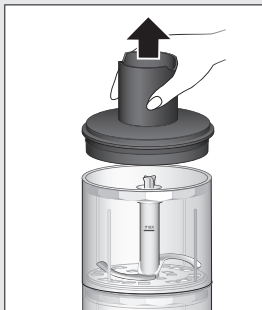















500 ml

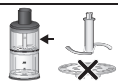

 max 1 min  3 min





								
								
	 2 cm	 2 cm	 2 cm	 2 cm		 2 cm	 2 cm	
max.	150 g	100 g	100 g	100 g	200 g	100 g	150 g	6 
	L							L
	S							S
	XS  C/E							 C/E
	13							13
								

E

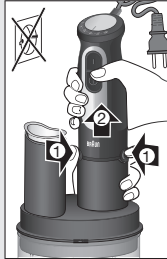
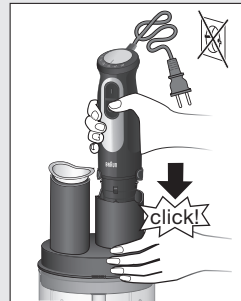
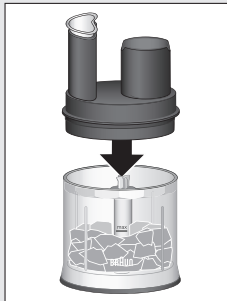
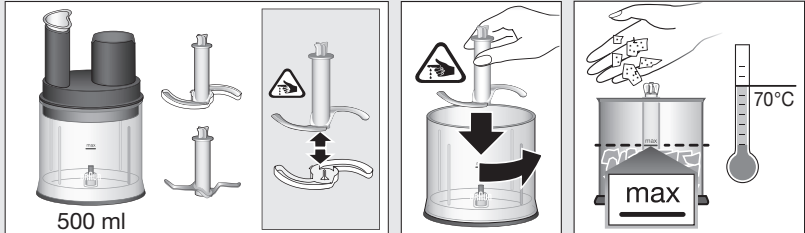

	2cm	2cm				2cm			
max.	300 g	200 g	200 g	30 g	20	200 g	300 g	350 g	5
sec.	10-25	20-30	5-10	5-10	5-10	10	20	30	5-10x pulse
			1-9		1-25	1-25	21	13-25	13-25
	turbo	turbo		turbo					turbo

F

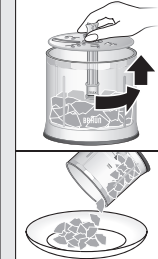
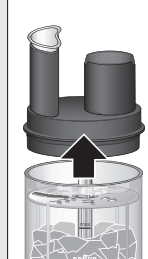
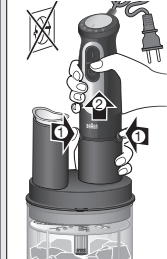
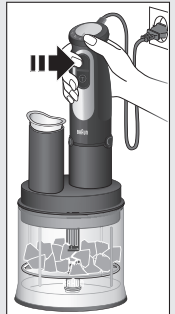
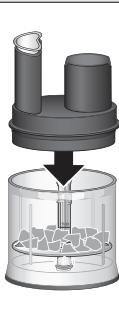
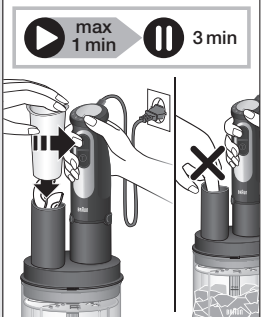
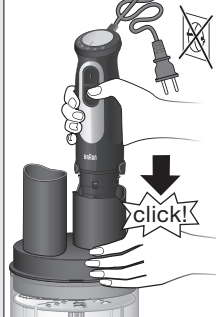
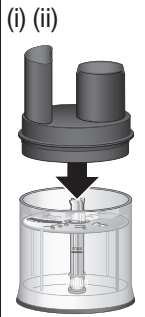
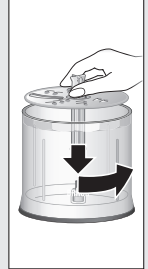
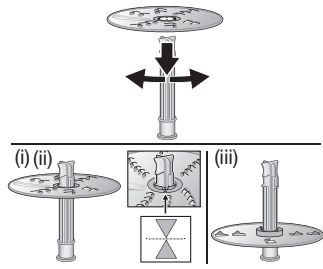
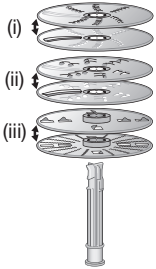

(i)										
(ii)										
	1			1-13		1			1	
	1	25			1				1	

(iii)												
	2cm	2cm	2cm	2cm	2cm	2cm	2cm	2cm	2cm	2cm	2cm	2cm
	120 g	120 g		120 g	120 g	120 g				120 g	120 g	120 g
									25			
	turbo	turbo		turbo	turbo	turbo				turbo	turbo	
	120 g	120 g	120 g		120 g			120 g	120 g	120 g	120 g	120 g
	25	25	25		25			25	25	25	25	25

G

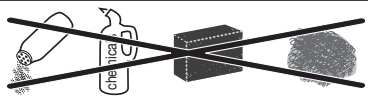
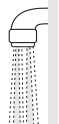
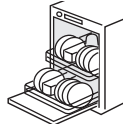
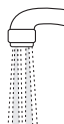
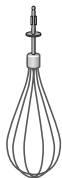
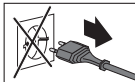

Before use

 Please read the user instructions carefully and completely before using the appliance and retain for future reference. Remove all packaging and labels and dispose them appropriately.

Caution

-  The blades are very sharp! To avoid injuries, please handle blades with utmost care.
- Care shall be taken when handling the sharp cutting blades, emptying the bowl and during cleaning.
- This appliance can be used by persons with reduced physical, sensory or mental capabilities or lack of experience and knowledge if they have been given supervision or instruction concerning use of the appliance in a safe way and if they understand the hazards involved.
- Children shall not play with the appliance.
- This appliance shall not be used by children.
- Children shall be kept away from the appliance and its main cord.
- Always switch off and unplug the appliance when it is left unattended and before assembling, disassembling, cleaning and storing.

- Do not reach into the filling shaft when the appliance is plugged in, especially while the motor is running. Always use the pusher to guide food through the shaft.
- This appliance is designed for household use only and for processing normal household quantities.
- Do not use any part in the microwave.
- Please clean all parts before first use or as required, following the instructions in the Care and Cleaning section.
- Keep hands, hair, clothing, as well as spatulas and other utensils away from whisks and dough hooks in operation to prevent personal injury. Do not contact moving parts during operation.
- Stop using the device if it is damaged.
- If the device falls into liquid, unplug, before reaching into the liquid.
- Be careful if hot liquid is poured into the food processor or blender as it can be ejected out of the appliance due to a sudden steaming.

Use only for mixing (soups, dips, sauces, baby food, drinks, smoothies, milkshakes), whipping (cream, beating egg whites) and chopping (hard cheese, onions, herbs, garlic, vegetables, bread, cracker, nuts,

ice), mashing (cooked vegetables/ fruits such as potatoes, sweet potatoes, tomatoes, plums, apples), grating, slicing and shredding.

«hc» Recipe example: Honey-Prunes (as a pancake stuffing or spread)

50 g prunes

75 g creamy honey

70 ml water (vanilla-flavour)

- Fill the «hc» chopper bowl with prunes and creamy honey.
- Store at 3 °C in refrigerator for 24 hours.
- Add 70 ml water (vanilla-flavoured).
- Chop 1 second at Turbo speed.

Use the chopper accessory «hc» (optional accessory available at your Braun Service Center; however not in every country).

AR

قبل الاستخدام

يُرجى قراءة تعليمات الاستخدام بعناية وبشكل تام قبل استخدام الجهاز والاحتفاظ بها للرجوع إليها في المستقبل. أزل جميع مواد التغليف والملصقات وتخلص منها بشكل مناسب.



تنبيه

- الشفرات حادة للغاية! لتجنب الإصابات، يُرجى التعامل مع الشفرات بحرص شديد.
- يجب توخي الحذر عند التعامل مع شفرات القطع الحادة، وتفريغ الوعاء أثناء التنظيف.
- يمكن استخدام هذا الجهاز بواسطة الأشخاص ذوي الإعاقات الجسدية أو القدرات النفسية أو العقلية المحدودة أو ممن لديهم خبرة قليلة ومعرفة محدودة، وذلك إذا تم إرشادهم أو تدريبهم على استخدام الجهاز بطريقة آمنة، وإذا كانوا على دراية بالمخاطر التي ينطوي عليها استخدام الجهاز.
- يجب ألا يعبث الأطفال بالجهاز.

يستخدم فقط لخلط (الحساء، التغميسات، الصلصات، أغذية الأطفال، المشروبات، العصائر، مخفوق الحليب)، لخفق (الكريمة، بيض البيض المخفوق) ولتقطيع (الجبن الصلب، البصل، الأعشاب، الثوم، الخضروات، الخبز، البسكويت، المكسرات، التلج)، لهرس (الخضار/ الفواكه المطبوخة مثل البطاطس، البطاطا الحلوة، الطماطم، الخوخ، التفاح)، للبشر، التقطيع والتقطيع.

«hc» مثال لوصفة: غسل الأراسية (مثل فطائر محلاة مضغوطة أو مفروقة)

50 جرام أراسية

75 جرام العسل الكرمي

70 ملي ماء (بنكهة الفانيليا)

- املاً وعاء المفرمة «hc» بالأراسية والعسل الكرمي.

- يجب ألا يستخدم الأطفال هذا الجهاز.
- يجب إبقاء الأطفال بعيداً عن الجهاز وعن سلك التيار الكهربائي الرئيسي الخاص به.
- يجب دائماً إيقاف تشغيل وفصل جهاز عند تركه دون رقابة وقبل التركيب وحال التجميع والفك والتنظيف والتخزين.
- لا تستخدم الجهاز إذا كانت المصفاة الدوارة أو الغطاء الواقي تالفاً أو توجد بأي منهما تشققات ظاهرة.
- تم تصميم هذا الجهاز للاستخدام المنزلي فقط ولأغراض تحضير الكميات المنزلية الطبيعية.
- لا تستخدم أي جزء من هذا الجهاز داخل الميكروويف.
- يرجى تنظيف كل الأجزاء قبل أول استخدام أو على النحو المطلوب، مع اتباع الإرشادات الموجودة في قسم الرعاية والتنظيف.
- حافظ على اليدين والشعر والملابس، بالإضافة إلى الملاعق والأدوات الأخرى بعيداً عن الخفاقات وخطاطيف العجين أثناء التشغيل لمنع الإصابة الشخصية. لا تقم بملامسة الأجزاء المتحركة أثناء التشغيل.
- توقف عن استخدام الجهاز في حالة تعرضه للتلف.
- في حالة سقوط الجهاز في السائل، افصله عن الكهرباء قبل الوصول إلى السائل.
- يجب توخي الحذر عند صب سائل ساخن في جهاز تحضير الطعام أو الخلاط، حيث أنه قد يندفع لخارج الجهاز نتيجة انبعاث البخار بشكل مفاجئ.

- تُخزن في درجة حرارة تبلغ 3 درجات مئوية في التلاجة لمدة 24 ساعة.
- أضيف 70 مللي ماء (بنكهة الفانيلا).
- التريو بسرعة واحدة ثانية لمدة بالخلط قم
- ق اختياري متوفر في مركز خدمة «ch» استخدام ملحق المفرمة الخاص بك؛ ولكن غير متوفر في كل الدول). Braun

